

# Detector Operations

John Kelley  
Detector Operations Manager

IceCube Management and Operations  
NSF Site Visit March 16, 2020





# Outline

- Deliverables and Overview
- Hardware Maintenance
- Operational Improvements
- Preparations for the Future

# Deliverables

- Keep the detector running!
  - reliable hardware and software
  - fast response time to problems
  - maintenance during austral summer at pole
- Ensure high-quality data to collaboration
  - monitoring and verification of every run
  - good / bad run tracking
- Support continued expansion of IceCube science
  - new features in software systems (e.g. multi-messenger program support)
  - design for integration of future detector expansions

# Online Systems Overview

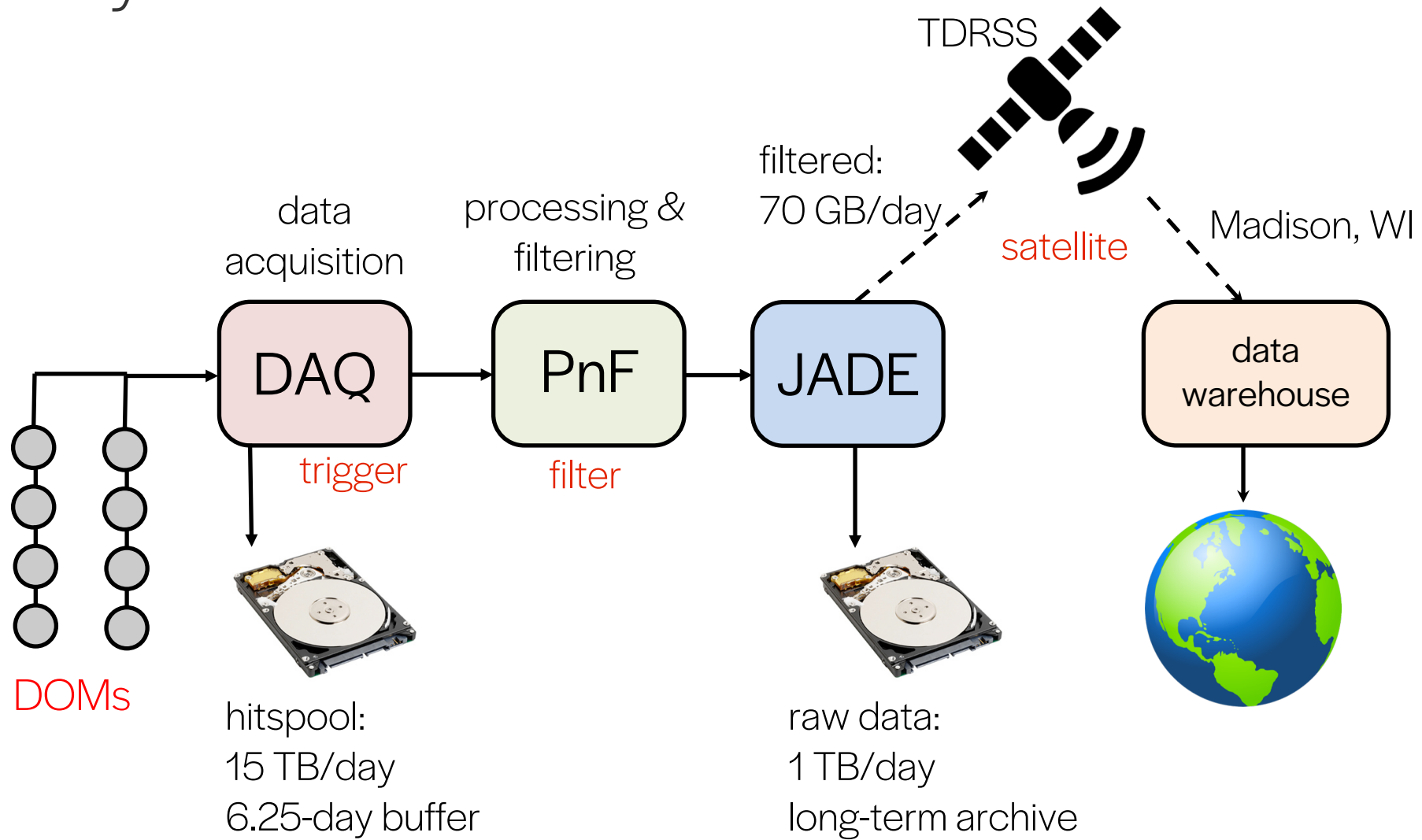



# Triggers and Filters

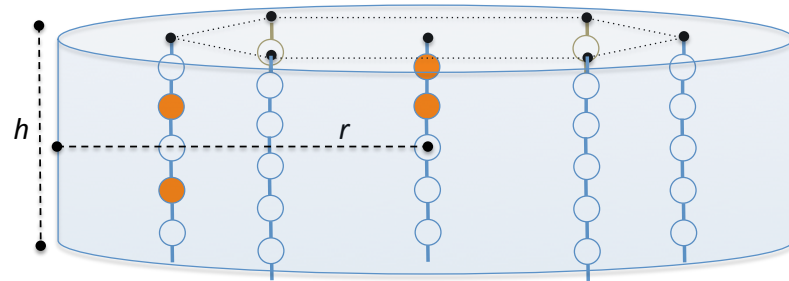

DAQ selects causal patterns of light (hits) from particle interactions

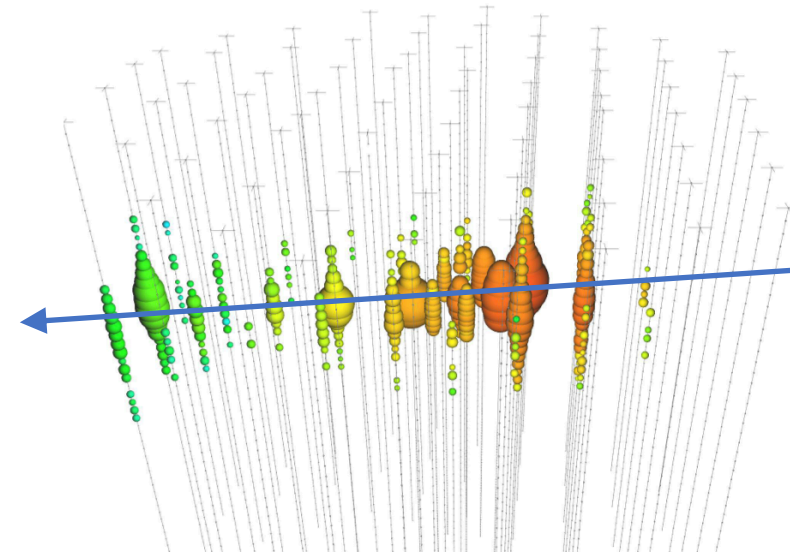

PnF performs fast reconstructions on those events, selects subsets interesting for analysis or real-time followup



# Historical Detector Uptime

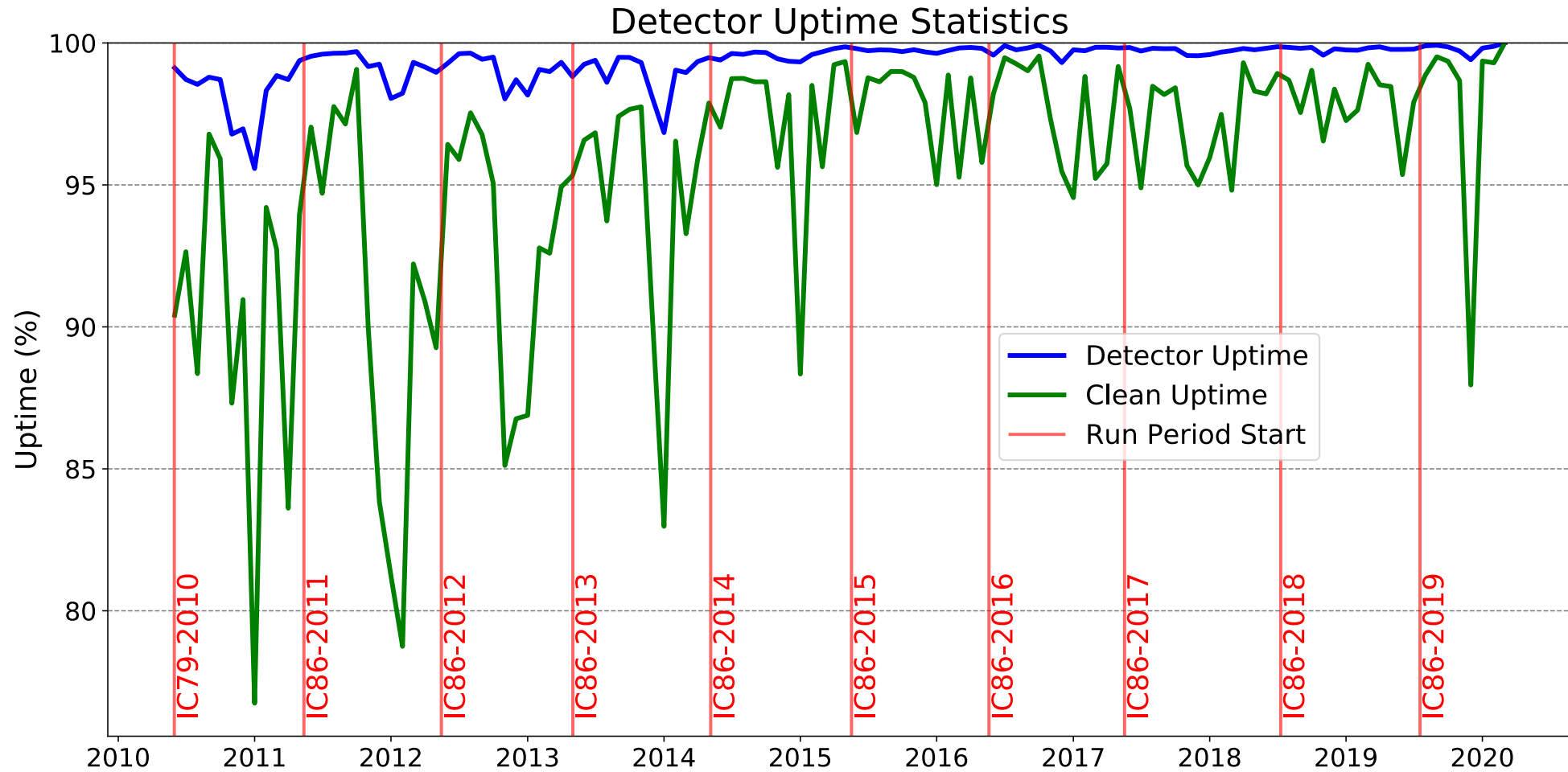



# Detector Uptime

1 Apr 2019 — 28 Feb 2020

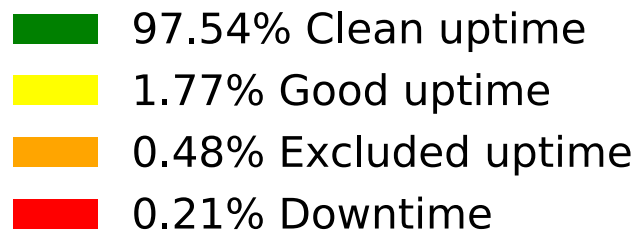
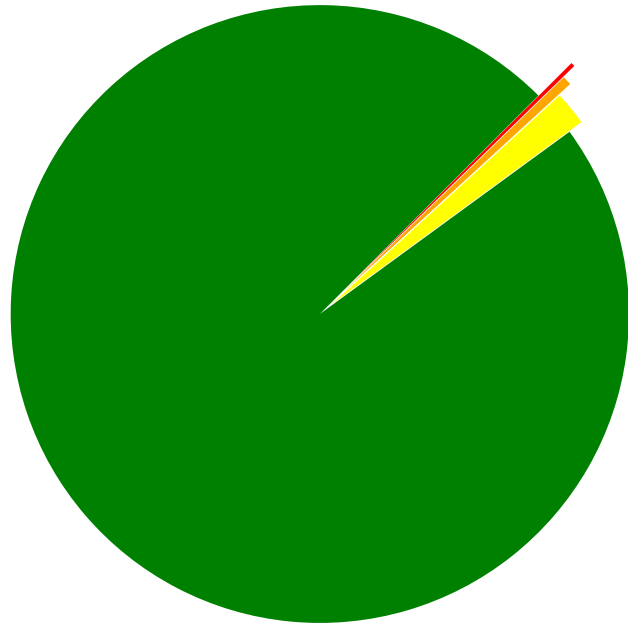

- Supported by a team of professionals
  - emphasis on testing, redundancy, and stability
- All hardware and software changes vetted on South Pole Test System (SPTS)
- 24/7 operational communications via Iridium
  - real-time detector status
  - winterover chat via IceCube Live + Slack
- Winterover paging system when intervention is needed



# Hardware Maintenance

# Inside the IceCube Laboratory (ICL)



- 18 racks of equipment
- 97 DOMHubs (1 / string + IceTop)
  - low-power single-board computers
  - custom DOM readout and clock fanout cards
  - DOM power supplies
- ~40 Dell PowerEdge servers
  - DAQ, PnF, infrastructure
- GPS receivers + fanouts, network switches, UPS, special devices



# Computing Maintenance

- Regular “life-cycle” server replacements
  - 100% replacement in 2013–14
  - 50% replacement in 2018–19
  - 50% replacement in 2019–20
- UPS battery replacements
- Annual security software patches
- Operating system software upgrades
  - planned for 2020–21



# Hardware Stability

Failures in this M&O period  
(from April 1, 2016)

Component	Failures
DOM power supplies (Acopian)	46
Hub power supplies	50
Hub memory	2
Hub hard drives	5
Hub single-board computers	1
DOM readout cards	1
Clock fanout cards	5 (1)
DOMs	3
master clock	1

- Most custom electronics (including DOMs) still reliable
  - 80% of failed clock fanout cards repaired (fuse)
- Hub hard drive failure rate increased in 2018
  - full replacement in 2019–20 season (after 6 years)
- DOMHub power supply failure rate high since 2016
  - redundant, so failure has no impact on data-taking
- DOM power supply failure rate unacceptably high
  - NOT redundant; failure takes down a string until replaced



# DOM Power Supply Upgrade

- Full replacement of Acopian power supplies in 2016–17
  - failure rate stabilized but did not decrease
- Acopian DOM power supplies swapped for Mean Wells
  - 50% completed in 18–19
  - 100% completed this season
  - **zero** failures as of Mar 2020
- Side benefit: increased efficiency
  - estimated power savings: 2.8 kW



Mean Well MSP-200-48  
with custom pigtail

# DOMHub (ATX) Power Supply Maintenance

- Winterovers discovered in 2019 that ~50% of DOMHub ATX power supply fans had failed
  - not surprising given MTBF of bearings
- Replaced ~200 dead fans this season with new model
- 15 modules with zero working fans died
  - sufficient spares





# Master Clock Upgrade

- IceCube timing provided by GPS “master clock”
- Issues with legacy Symmetricom ET6000
  - buggy, unsupported firmware
  - instability with one unit at pole
- Identified replacement: Spectracom SecureSync
  - running at pole as White Rabbit master clock since December 2017
  - validation at South Pole Test System in summer 2018
  - primary master clock upgraded 2018–19
  - backup master clock upgraded 2019–20

Spectracom SecureSync 1200

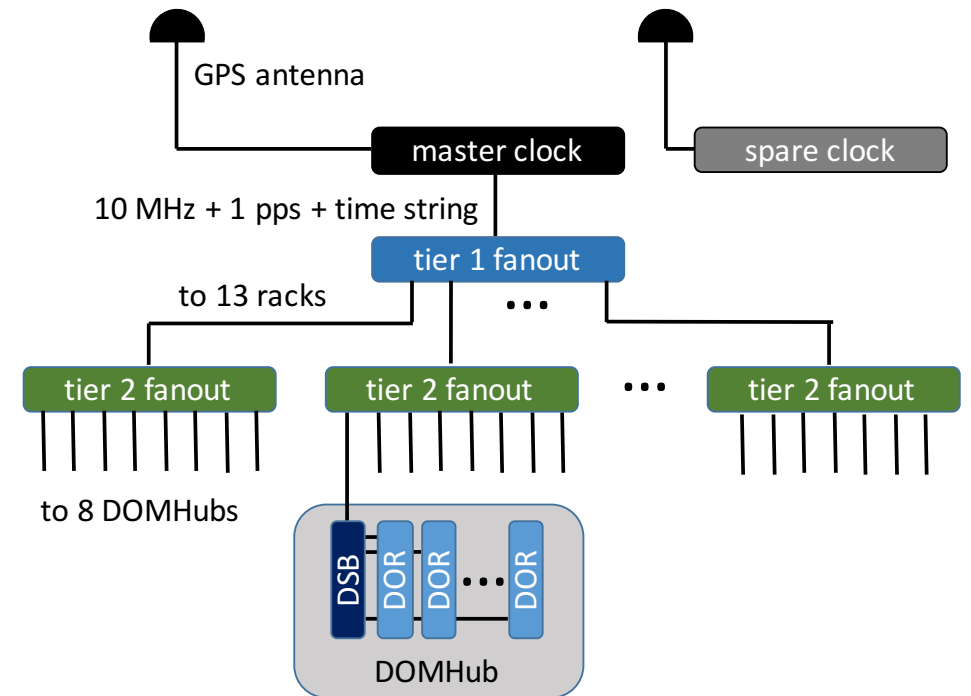

# Planned Hardware Maintenance

- Network switch lifetime replacement (21–22)
- UPS lifetime replacement (22–23/23–24)
- Server lifetime replacement (23–24/24–25)
- DOMHub upgrade (24–25/25–26)
  - existing custom hardware has lasted 15–20 years, but difficult/impossible to replace
  - move to homogenous Upgrade-style hardware for efficient maintenance
  - requires firmware development

Upgrade mini-FieldHub

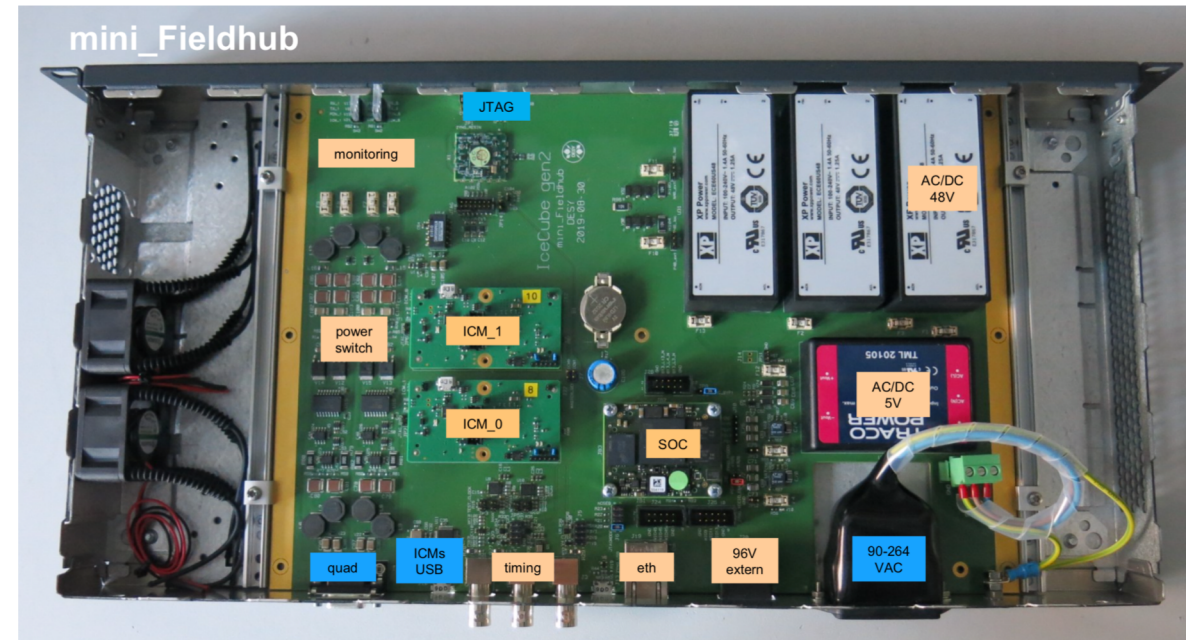



# IceTop Maintenance

# Impact and Mitigation of Snow Accumulation

- Increasing snow accumulation on tanks:
  - increases IceTop energy threshold
  - adds large systematic error to composition analyses
- Plan to restore efficiency and enhance cosmic-ray air shower reconstruction capabilities
  - elevated scintillator panels
  - broadband radio antennas

Snow Depth on IceTop tanks Oct/2016

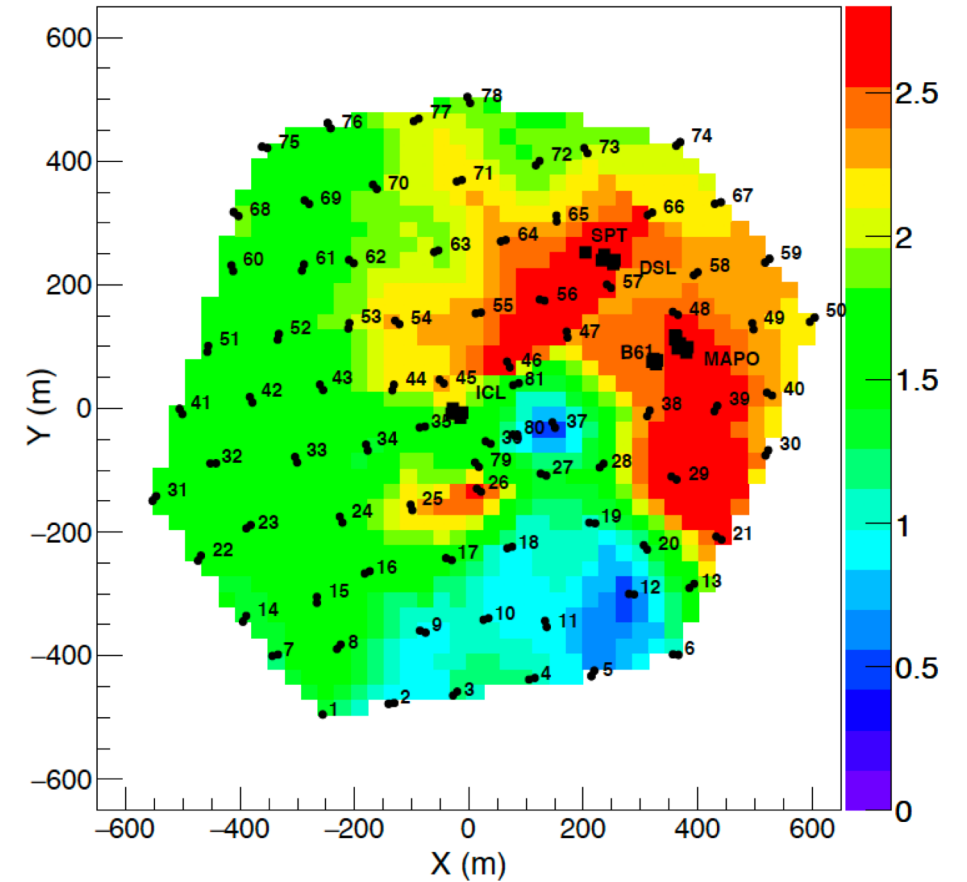

# Surface Array Station Status

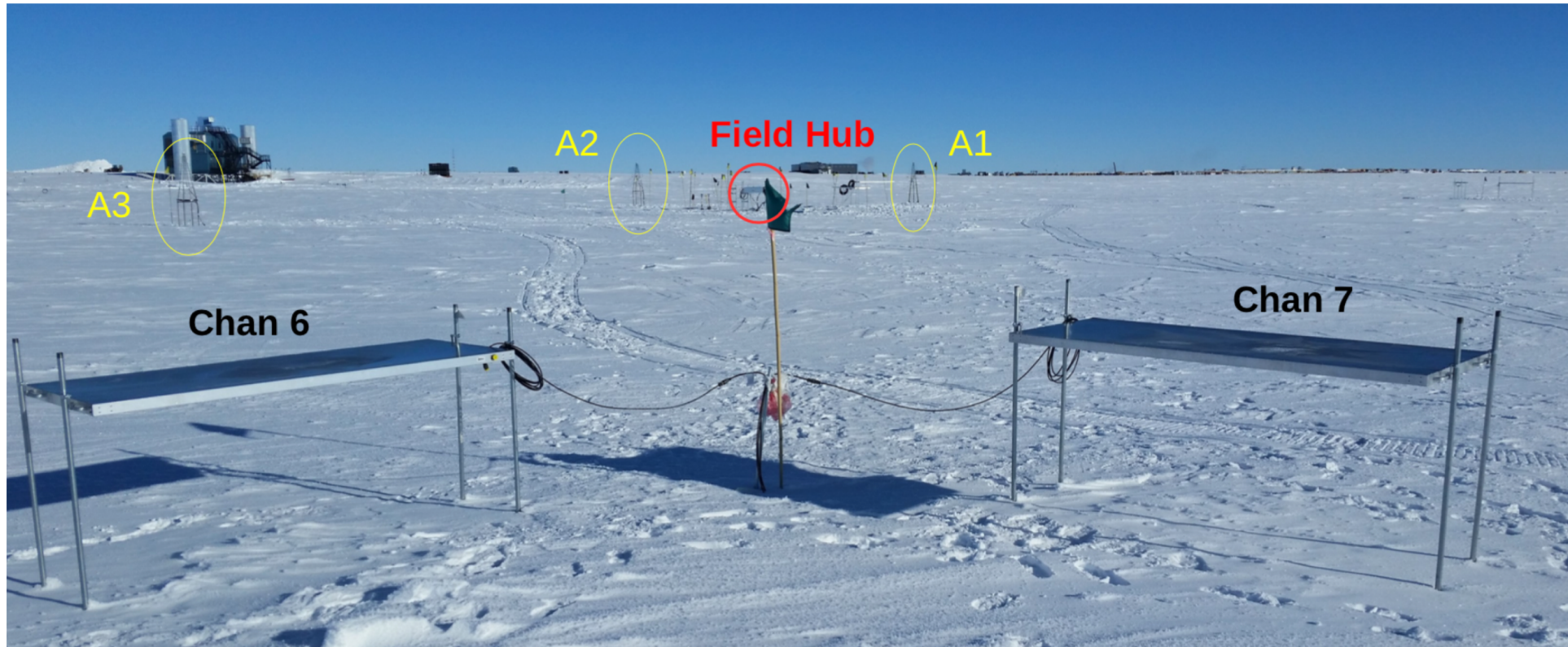

- Prototype hybrid station 2019–20 upgraded to production electronics
- All instrumentation and electronics elevated and able to be raised
- No induced snow drifting observed with previous deployments



# Technology Platform for Upgrade and IceCube-Gen2

prototype elevated FieldHub

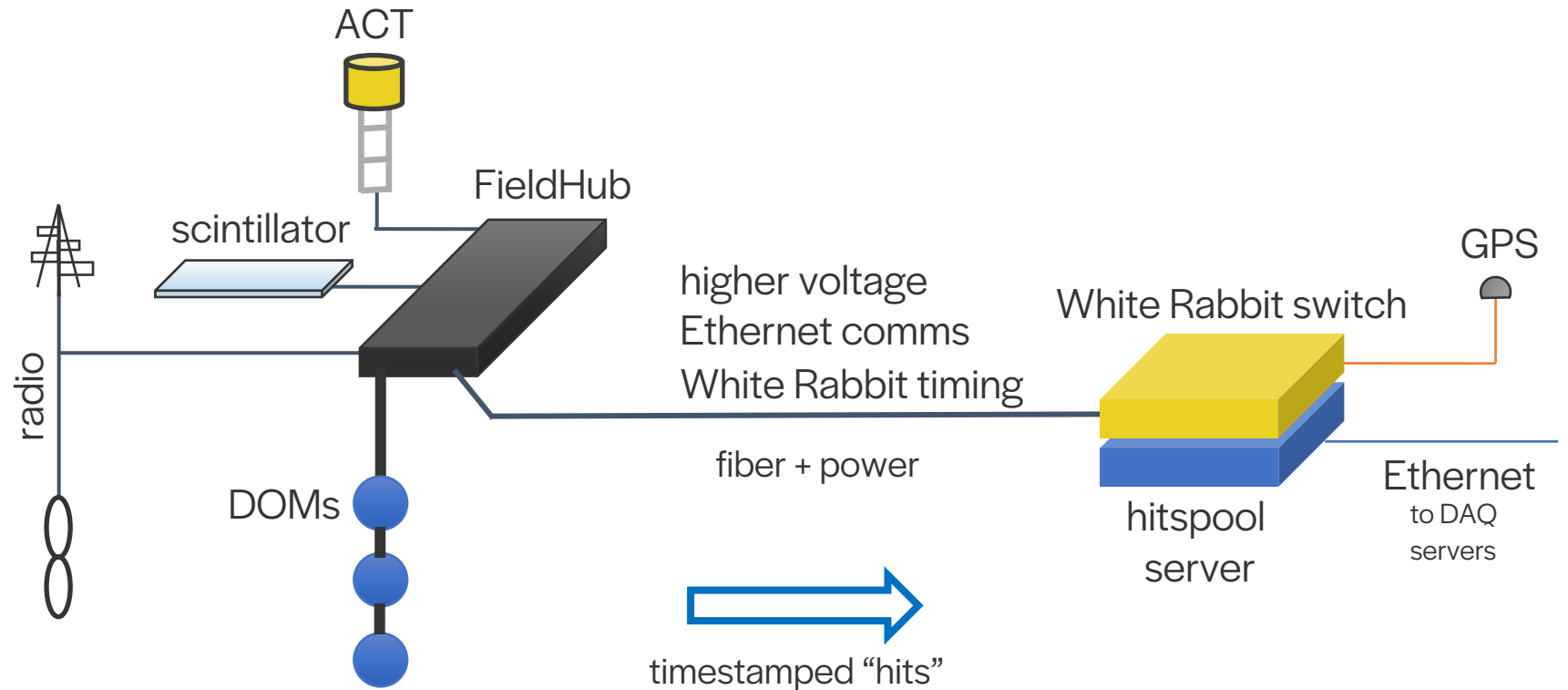
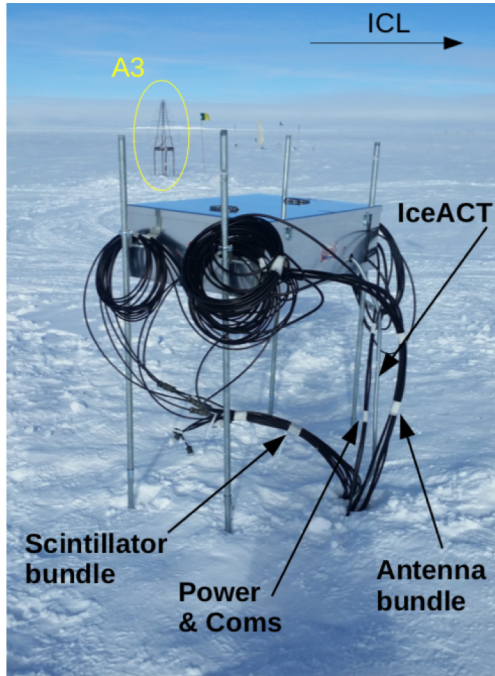

Standard comms/power/timing architecture supports a wide variety of instrumentation

# Surface Array Upgrade

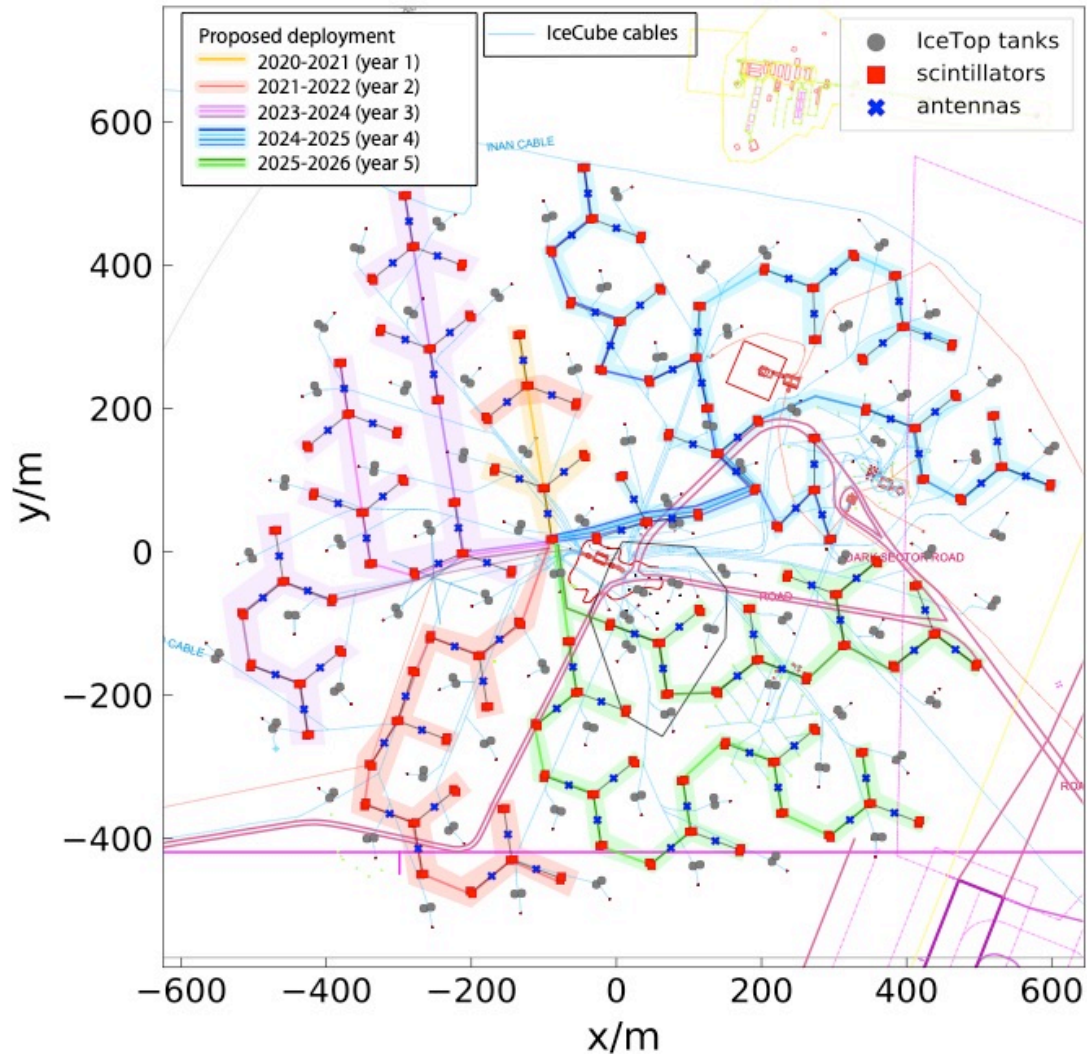

- Restore and enhance IceTop functionality with full scintillator + radio array
  - instrumentation funded by in-kind contributions
- Logistics and environmental impact discussed with stakeholders Nov. 2019
- Will be included in next M&O proposal
  - updated deployment schedule starting 21-22
  - very limited activity 20-21 season

# Additional Operational Improvements



# External Hitspool Alerts

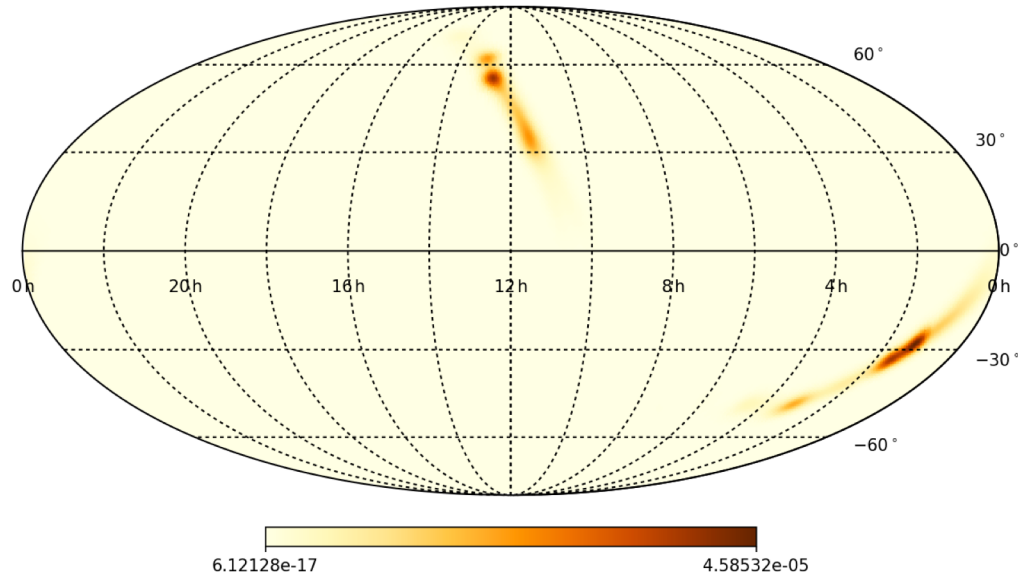

Skymap for LVC S200219ac  
gravitational wave candidate

- Receive external multi-messenger alerts for gravitational wave (LIGO/VIRGO) and supernova (SNEWS) event
- Automatically save hitspool data for subthreshold analyses
  - archive to disk and/or transfer via satellite
- 34 LIGO/Virgo-alert hitspool data captures since July 2019

# Realtime Neutrino Candidates in IceCube Live

## IceCube Realtime

### Latest Events

<b>neutrino</b> 2020-03-10 14:56:58.968 3 minutes ago	<b>EHE</b> 2019-09-22 09:42:45.628 6 months ago	<b>ESTRES</b> 2020-03-10 14:06:50.655 an hour ago	<b>HESE</b> 2020-03-10 14:44:35.697 16 minutes ago
---	---	---	--

### Event Catalog [show Alerts](#)

Time range: 2020-02-13 04:00:00 → 2020-02-13 04:10:00

Streams  
 neutrino  EHE  ESTRES  HESE

Run	Evt #	Event Time	Streams
133726	43085531	2020-02-13 04:09:31	neutrino
133726	42936048	2020-02-13 04:08:39	neutrino
133726	42892542	2020-02-13 04:08:24	neutrino
133726	42775427	2020-02-13 04:07:44	neutrino
133726	42080620	2020-02-13 04:03:45	neutrino
133726	41983928	2020-02-13 04:03:12	neutrino
133726	41674235	2020-02-13 04:01:25	neutrino

Showing 1 to 7 of 7 entries 1 row selected

Previous  Next

### Latencies ▲

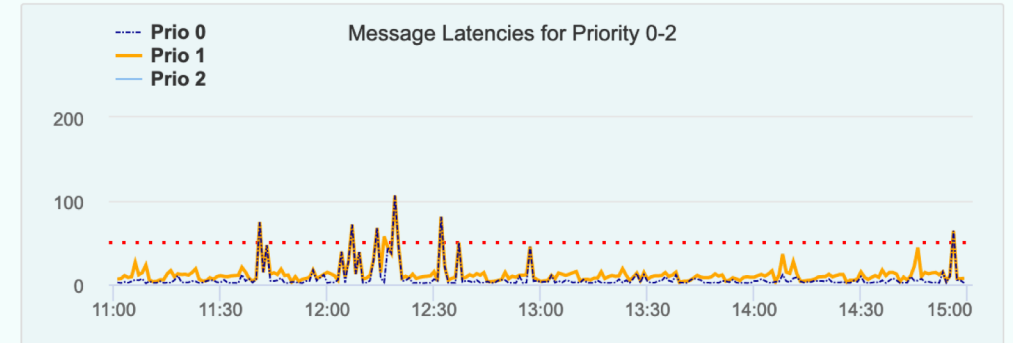

### Event Details



**Event:** run00133726.evt000042775427  
**Streams:** neutrino  
**Latency:** 24s (tx 3s)  
**Data:** data

# Realtime Neutrino Alerts in IceCube Live

## IceCube Realtime

### Latest Events

<b>neutrino</b> 2020-03-10 14:56:58.968 3 minutes ago	<b>EHE</b> 2019-09-22 09:42:45.628 6 months ago	<b>ESTRES</b> 2020-03-10 14:06:50.655 an hour ago	<b>HESE</b> 2020-03-10 14:44:35.697 16 minutes ago
---	---	---	--

### Event Catalog

Time range: 20  
Streams  
neutrino  EHE

Run
133726
133726
133726
133726
133726
133726
133726
133726

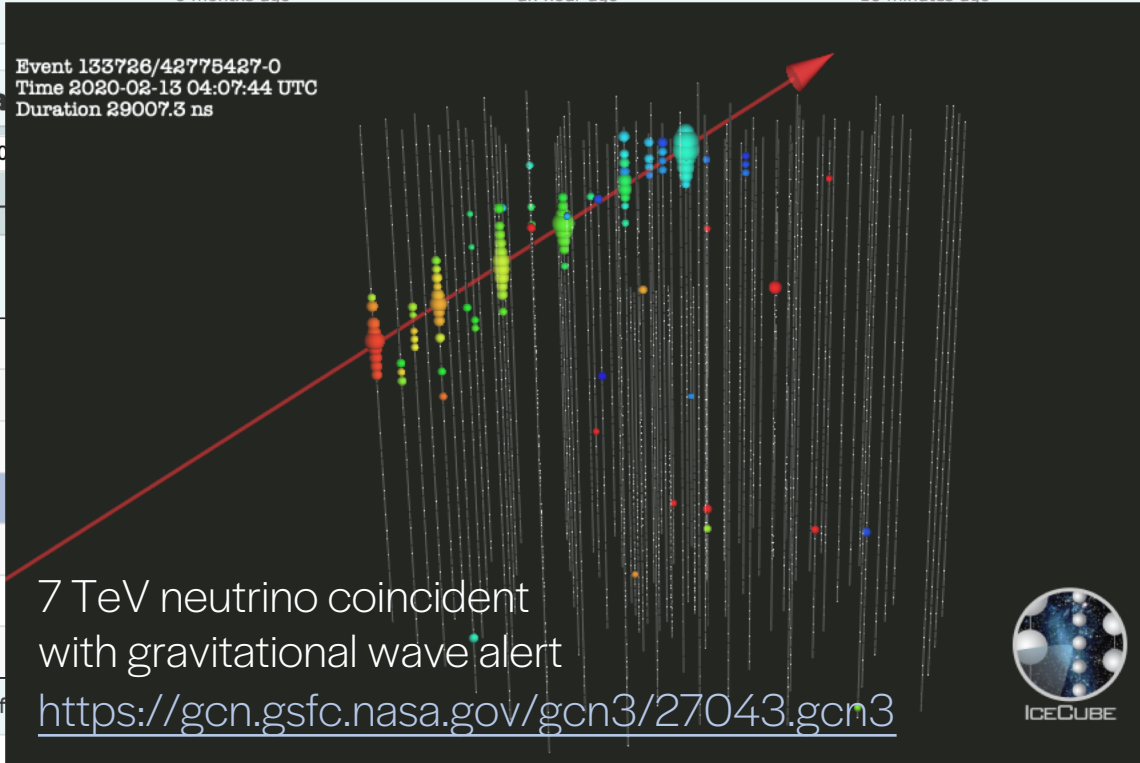

### Latencies ⚠

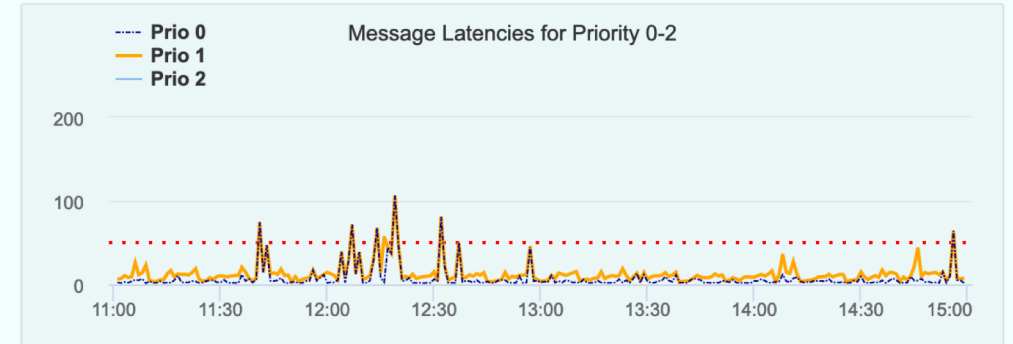

### Event Details



**Event:** run00133726.evt000042775427  
**Streams:** neutrino  
**Latency:** 24s (tx 3s)  
**Data:** data



# DAQ Trigger Efficiency

Urban\_Harvest9\_rc1 test run CPU usage  
(lower is better)

trigger -- CPU utilization

4 Hours (03.03.20 23:09 - 04.03.20 3:09)

Datasource user

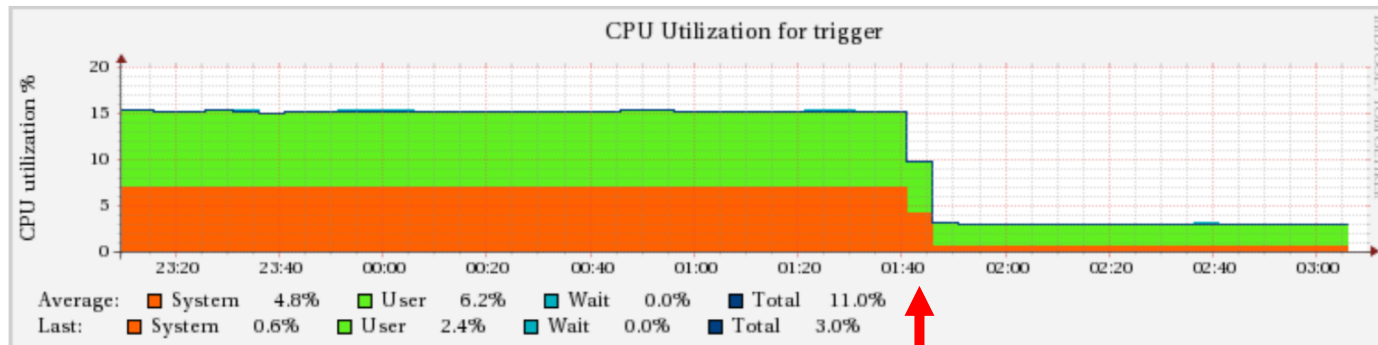

- Server upgrade exposed inefficiency in DAQ trigger code
  - input hit queues bogged down
- Optimized with lock-free queues
  - CPU usage reduced by factor of 5
- Important for the Upgrade
  - no hardware local coincidence
  - more noise hits into trigger
- Changes in computing often require associated changes in software

# Preparations for the Upgrade and Beyond

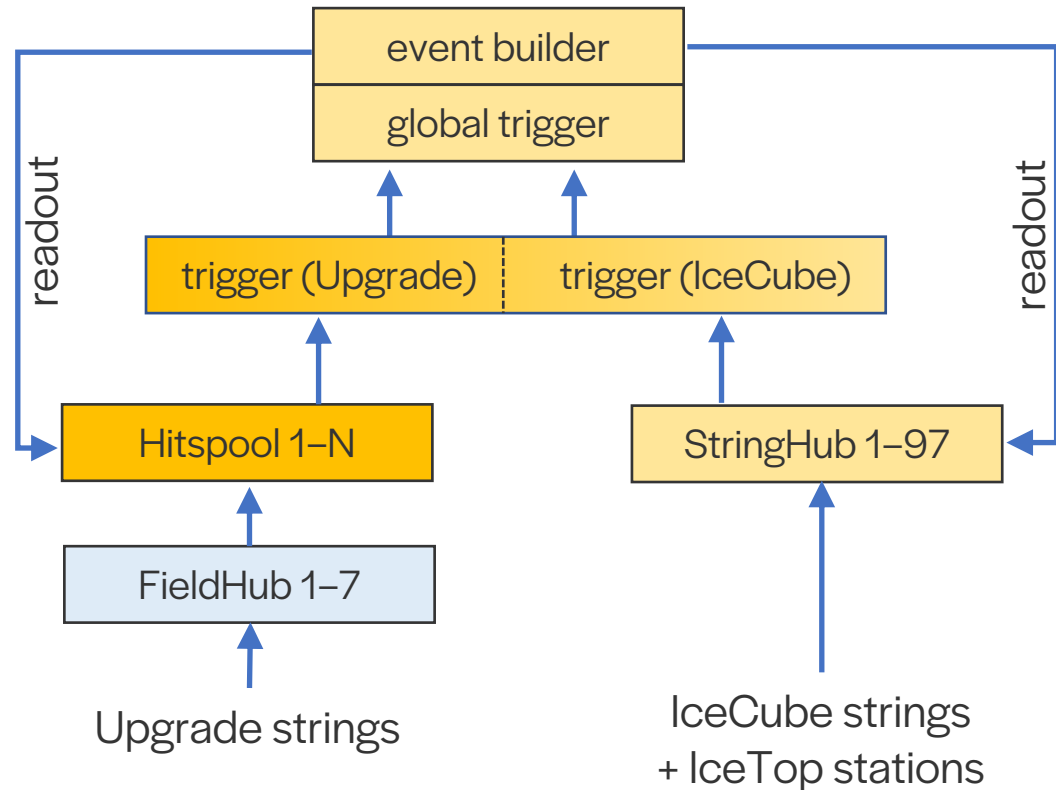

DAQ integration

- M&O development of online software means:
  - major technical risks / fragile systems already replaced
  - architectures designed to be expandable and scalable
- Upgrade will be integrated into IceCube, not the other way around

# Summary

- IceCube is operating smoothly
  - through regular and vigilant maintenance
  - addressing problematic hardware and software
- Continuously expanding the science capabilities
- Well-prepared for the Upgrade and beyond
  - investment in maintenance paying off
  - modifying existing software instead of starting from scratch



# Backup

# Logistics Support for Surface Array (Updated)

season	#stations (up to)	cargo [lbs]	trenching [km]	highest pop
2020-21	1	1k	0.5	3 (3 weeks)
2021-22	5	9k	1.4	5 (3 weeks)
2022-23	0	0	0	0
2023-24	7	12.6k	2.4	5 (2.5 weeks)
2024-25	9	16.2k	3	5 (3 weeks)
2025-26	10	18k	2.8	5 (3.5 weeks)

Proposed surface array deployment schedule starting in 21–22  
(20–21 is relocation of prototype station)